



Ixion Illuminator Range

Models covered by this manual:

UFO35G IXION-A
UFO35P IXION-A
UFO42G IXION-A
UFO42P IXION-A
UFO50G IXION-A
UFO50P IXION-A
UFO75G IXION-A
UFO75P IXION-A
UFO100G IXION-A
UFO100P IXION-A

Please read this manual fully before installing, operating or performing maintenance on the illuminator unit.

INTRODUCTION

Thank you for purchasing this UFO illuminator.

Please read these instructions fully before connecting your unit to the electrical supply, and keep them for future reference.

The UFO Ixion range of illuminators utilize a dichroic tungsten halogen bulb and is suitable for use with either glass or PMMA fiber-optic harness

The Ixion is powered by an external 12VDC power supply unit compatible with the local mains supply.

The Ixion features very low noise and heat output and is available with a choice of five lamp sizes - 35W, 42W, 50W, 75W or 100W.

IMPORTANT

THIS PRODUCT MUST BE INSTALLED IN ACCORDANCE WITH THE APPLICABLE INSTALLATION CODE BY A PERSON FAMILIAR WITH THE CONSTRUCTION AND OPERATION OF THE PRODUCT AND THE HAZARDS INVOLVED.



Do not operate without complete lamp enclosure in place or if lens is damaged.

KEEP HARNESS IN PLACE WHEN IN OPERATION.

CAUTION: Hot surface. Keep away from curtains and other combustible materials.

WARNING: RISK OF FIRE/INJURY TO PERSONS. Keep away from combustibles. Unplug to change lamp. Do not touch lamp.

WARNING: RISK OF FIRE. Do not place lamp where the overhead surface is closer than 0.2m to the light source.

IMPORTANT SAFETY INFORMATION

INSTRUCTIONS PERTAINING TO A RISK OF FIRE, ELECTRIC SHOCK OR INJURY TO PERSONS

IMPORTANT SAFETY INSTRUCTIONS

Lighted Lamp is HOT:

WARNING – To reduce the risk of FIRE, ELECTRIC SHOCK OR INJURY TO PERSONS:

1. Unplug and allow to cool before replacing lamp.
2. Lamp gets HOT quickly! Only contact plug when turning on.
3. Do not touch hot lens, guard, or enclosure.
4. Do not remain in light if skin feels warm.
5. Do not look directly at lighted lamp.
6. Keep lamp away from materials that may burn.
7. Use only with a 100W or smaller lamp.
8. Do not touch the lamp at any time. Use a soft cloth. Oil from skin may damage lamp.
9. Do not operate product with missing or damaged guard, lamp containment barrier, lens or fiber-optic harness.

SAVE THESE INSTRUCTIONS

- Always disconnect the unit from the power supply before opening or attempting to perform any work on it.
- **UNIT MAY GET HOT** - always allow unit to cool down before handling or moving it.
- Do not touch or attempt to remove the lamp while it is hot.
- Ensure that the power supply is correct for the unit before powering it up.
- Do not expose the unit to rain or moisture.
- Keep away from all combustible materials.
- Never attempt to tamper with the wiring or other internal components.
- Keep the unit away from gas, oil and any other flammable or explosive materials.
- Indoor use only.

LIGHT SOURCE LAYOUT

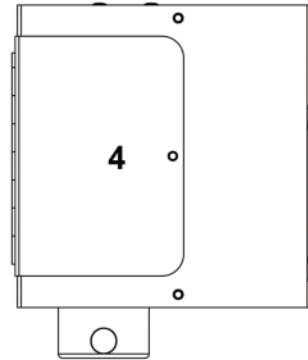
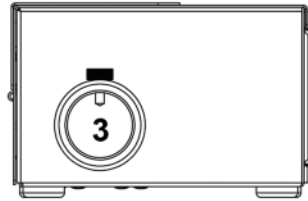
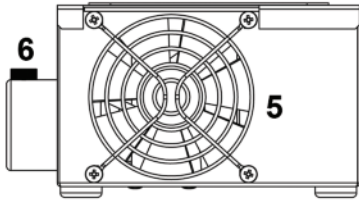
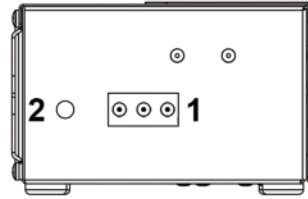

Item	Description
1	Power supply input socket
2	Power LED
3	Fiber port
4	Lamp access hatch
5	Cooling fan
6	Fiber connector securing screw

INSTALLATION GUIDE

In order for the Ixion illuminator to function safely and efficiently it must be installed according to this user manual. Please read all sections thoroughly before switching on the illuminator.

POWER SUPPLY REQUIREMENTS

Before plugging in the unit, please make sure that the supply is correct. Failure to do so could cause the unit to malfunction. The Ixion ballast requires a 120VAC, 60Hz supply and it **MUST BE GROUNDED**. The illuminator power supply units are provided with a cordset fitted with a standard 3-pin plug.

POSITIONING THE UNIT

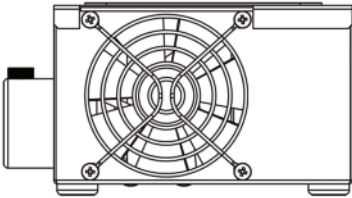

**Standard horizontal mounting
(on shelf / table)**

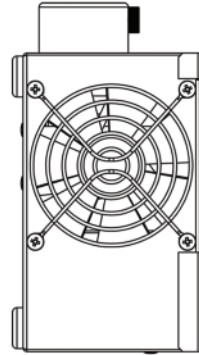

**Vertical mounting
(fixed to wall)**

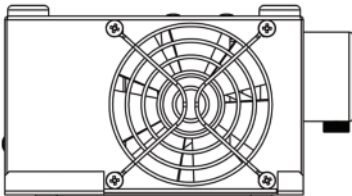

**Upside down mounting
(fixed to underside of shelf)**

The illuminator can be fixed to a suitable surface or be used unfixed by utilizing the four rubber feet on base. Note: for most applications fixing is recommended.

The illuminator itself may be mounted in any other orientation than pointing the exhaust vent downwards.

The illuminator can be fixed to a suitable surface by using the two keyhole slots on the base of the unit. Horizontal mounting can be achieved with the keyhole slots facing downwards i.e. screwed to the top of a flat surface, or upwards, i.e. screwed to the underside of a shelf, etc.

INSTALLATION GUIDE (Continued)

Verify that the supporting structure can safely bear the weight of all installed units, cables and any other equipment.

For horizontal mounting, it is recommended that the illuminator is secured to a solid surface using 2 x M4 or M5 screws or bolts and the keyhole slots. This is particularly important if the illuminator location is not at ground floor level.

To mount the illuminator vertically, first securely install 2 x M4 or M5 screws or bolts at the required distances so that they will line up with the keyhole slots. The illuminator can then be mounted onto them and slid into position. The bolts or screws **MUST** then be fully tightened.

To mount the illuminator under a surface, first securely install 2 x M4 or M5 screws or bolts at the required distances so that they will line up with the keyhole slots. The illuminator can then be mounted onto them and slid into position. The bolts or screws **MUST** then be fully tightened.

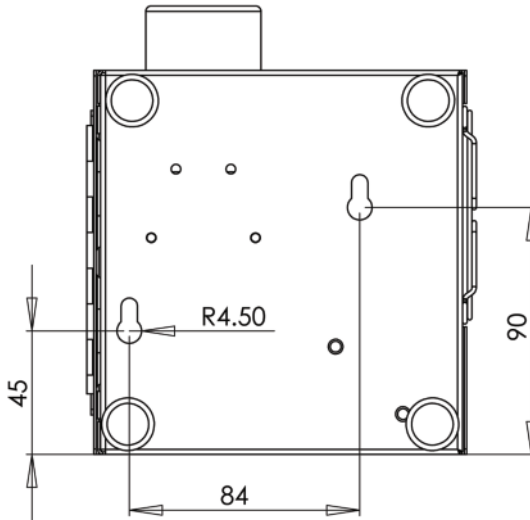

CLEARANCE / VENTILATION

It is recommended that a gap of 200mm (8") or more is left around the unit. This is to allow air to circulate and prevent overheating. The location must have free ventilation.

INSTALLATION GUIDE (Continued)

CONNECTION

There are 2 connections required - the fiber port and the external power supply unit. Connect and secure the fiber optic connector to the fiber port before connecting the electrical supply. Never run the illuminator with the fiber connector unplugged.

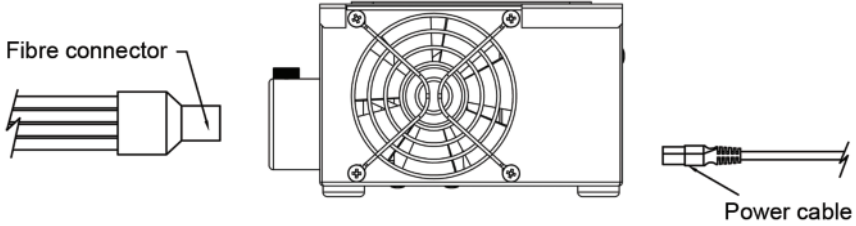

OPERATION

Plug the external power supply unit into the electrical supply socket and then into the illuminator. Switch on the power to the illuminator and it will start up automatically. Light will be output from the port connector and out through the fiber harness.

If no light is produced, please consult the TROUBLESHOOTING section in this manual.

MAINTENANCE

LAMP REPLACEMENT

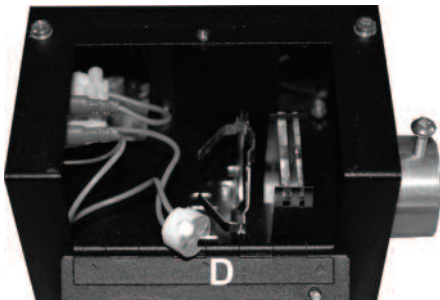
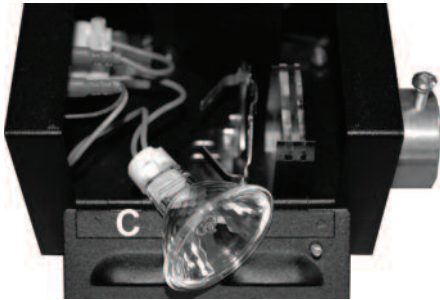
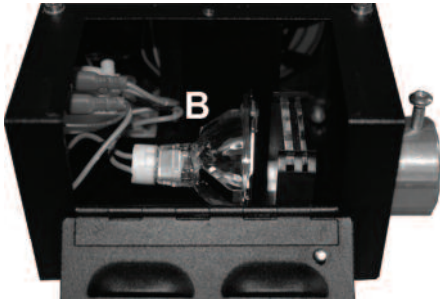

- 1) Unplug unit from electrical supply and allow to cool.
- 2) Remove the single screw (A) which secures the unit's lamp access hatch.
- 3) Open the lamp access hatch and you will see the lamp sitting in its holder and attached to a ceramic plug (B).
- 4) With the lamp still attached to the ceramic plug, pull it upwards and out of its holder (C).
- 5) Pull the ceramic plug from the end of the old lamp (D).
- 6) Connect the new lamp to the ceramic plug making sure that you use a lamp of the same specification as to that which was removed. Also make sure not to touch the front of the lamp.
- 7) Slide the lamp back into its holder.
- 8) Close the lamp access hatch and secure with the retaining screw.

MAINTENANCE (Continued)

FUSE REPLACEMENT



- 1) Unplug unit from electrical supply and allow to cool.
- 2) Remove the single screw (A, opposite) which secures the unit's lamp access hatch.
- 3) The fuse is located in a holder on the back wall at the top of the unit (E).
- 4) Remove the fuse from its holder
- 5) See page 10 for fuse specification and replace with same type.
- 6) Push the new fuse into its holder
- 7) Close the lamp access hatch and secure with the retaining screw.

CLEANING THE UNIT

Disconnect unit from power supply and allow to cool before attempting any cleaning of the unit.

The body of the unit can be cleaned with a soft, damp cloth - do not use any abrasives on the unit.

The fans and vents should be kept clear by periodically blowing them out with compressed air.

Non-abrasive glass cleaner can be used to clean the glass lens inside the unit.

Please note that a record of all maintenance MUST be kept in the table below, indicating what maintenance was undertaken and when.

Date	Maintenance Undertaken

TROUBLESHOOTING

Problem	Probable cause(s)	Remedy
Unit is completely dead - Lamp and LED power indicator are not illuminated	Main fuse blown	Check and replace fuse.
	No power to unit	Check that power is switched on and power supply is plugged in.
LED power indicator & fan are on, but no light is output	Lamp blown	Replace lamp
	Thermal switch activated	Allow unit to cool for 5 to 10 minutes and investigate reason for overheating
	Lamp wires are not connected	Check plug connection - ensure lamp is properly seated in its holder and the pins are fully mated
Poor light output	Lamp needs replacing	Replace lamp
	Unit needs cleaning	Clean glass lens
	Incorrect power supply	Ensure power supply is 120VAC 60Hz
	Fiber port connector not plugged in correctly	Ensure fiber port connector is plugged in correctly, and that the screw is tightened up properly
Lamp going on & off randomly	Unit is overheating	Allow unit to cool for 5 to 10 minutes and investigate reason for overheating

TECHNICAL SPECIFICATIONS

Description	35W	42W	50W	75W	100W
Port connector size	30mm	30mm	30mm	30mm	30mm
Fiber type	Glass/PMMA	Glass/PMMA	Glass/PMMA	Glass/PMMA	Glass/PMMA
Ballast supply voltage	120 VAC 60Hz	120 VAC 60Hz	120 VAC 60Hz	120 VAC 60Hz	120 VAC 60Hz
Lamp power	35W	42W	50W	75W	100W
Input power @ 120VAC	33.6VA	40.8VA	69.6VA	91.2VA	127.2VA
Maximum current @ 120VAC	0.149A	0.172A	0.31A	0.49A	0.73A
Min. ambient temp.	-20°C	-20°C	-20°C	-20°C	-20°C
Max. ambient temp.	40°C	40°C	40°C	40°C	40°C
Thermal protection	Thermal switch	Thermal switch	Thermal switch	Thermal switch	Thermal switch
Fan type	Papst 8412NGLE (12V)	Papst 8412NGLE (12V)	Papst 8412NGLE (12V)	Papst 8412NGLE (12V)	Papst 8412NGLE (12V)
Fuse	0.5A	0.5A	0.5A	0.5A	0.5A
Lamp type	Tungsten halogen	Tungsten halogen	Tungsten halogen	Tungsten halogen	Tungsten halogen
Lamp model	FMT	Philips 13861	EXN	EYF	EFP Osram 64637
Lamp color temp.	2950k	2900k	3000k	3000k	3000k
Acoustic rating	31.0dB(A)	31.0dB(A)	31.0dB(A)	31.0dB(A)	31.0dB(A)
Operating environment	Indoor / dry	Indoor / dry	Indoor / dry	Indoor / dry	Indoor / dry
Material	Sheet steel	Sheet steel	Sheet steel	Sheet steel	Sheet steel
Color	Black	Black	Black	Black	Black
Size	164x140x90mm	164x140x90mm	164x140x90mm	164x140x90mm	164x140x90mm
Weight	0.9kg	0.9kg	0.9kg	0.9kg	0.9kg

