

PRODUCT SPECIFICATION SHEET



Rev. C1

UFO Light Bar Linear Lighting

The UFO Light Bar system is a custom fabrication using the UFO 34DA or UFO 34DB mini trumpet fitting. Each Light Bar is made to order. The fittings and optionally small interspersed points of light can be placed at regular or irregular intervals to suit what is being illuminated. Bars are available black or white as standard and in a range of powder coat colours to your specified RAL colour. The 34D eyeballs are always black while the trumpets can be black or painted to a custom colour. End caps are available if required. The normal active diameter of fibre used is 3mm (2mm can be used to good effect with metal halide light sources). Brackets can be supplied if required and the Clip Style bracket, which can be retrofitted, is ideal for horizontal mounting. Brackets can be pre-fitted.

The UFO 34D has two versions -
 UFO 34DA with c. 20 - 30 degree focus
 UFO 34DB with c. 55 - 60 degree focus

Light Bars using 2mm or 3mm fibre in fittings with optional 1.5mm or 1.8mm points for infill* with a single 30mm common end and tails from one end.

Profile	1.5mm*	1.8mm*	2.0mm	3.0mm
27mm (1.06")	35	30	15	10
32mm (1.26")	50	45	22	12
38mm (1.5")	70	65	35	18
44mm (1.73")	100	90	55	34

When using a mini common end connector, the maximum tails per bar is 10 of 3mm fibre or 26 of 2mm fibre. Where infill points * are used, reduce the maximum number of fittings proportionally.

Profile	A	X	Y	Z
27mm (1.06")	41	29	8	9
32mm (1.26")	48	34	8	9
38mm (1.5")	52	40	8	9
44mm (1.73")	61	46	8	9

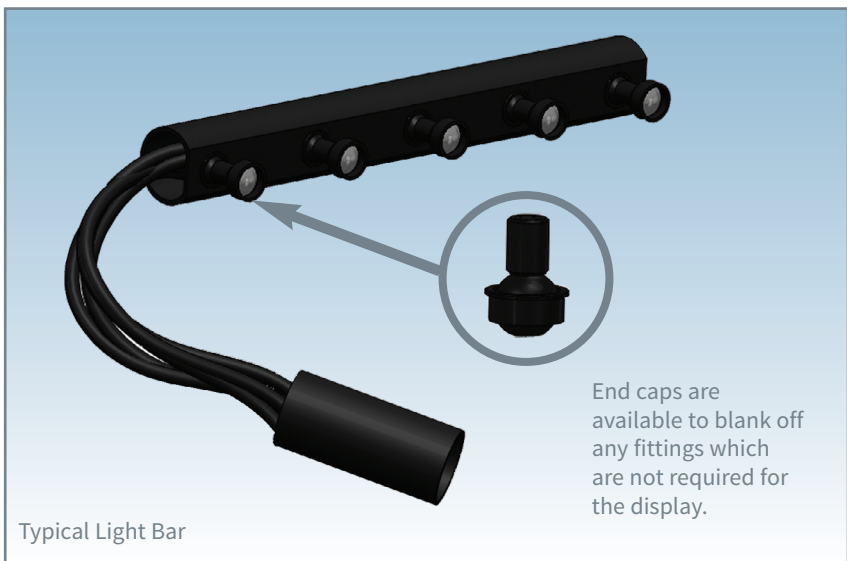
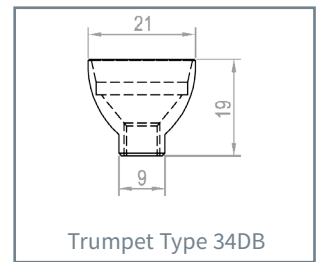
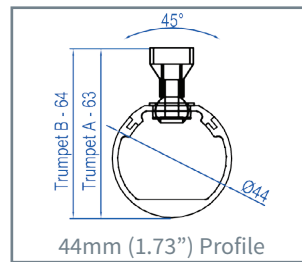
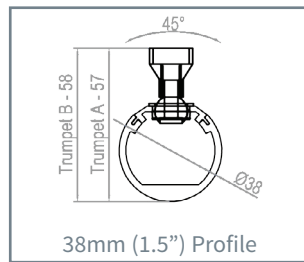
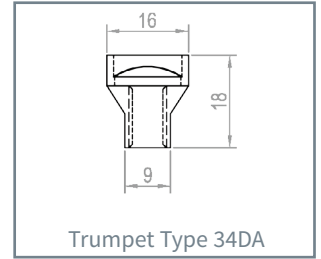
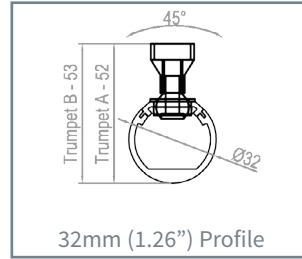
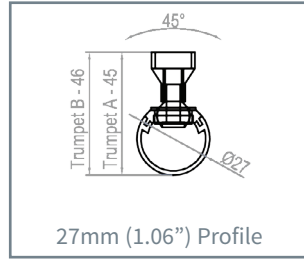
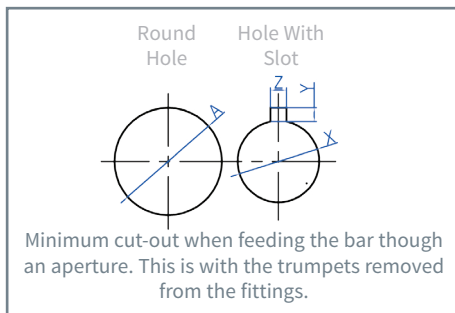

Note that drawing dimensions are shown in mm



PRODUCT SPECIFICATION SHEET

UFO Light Tube & Bar Mounting Options



Rev. C1

A number of types of accessory brackets are available for Tubes and Bars. For Light Wand brackets please see the Light Wand section. The Round Brackets are for vertical or horizontal mounting of tubes. The tube is locked with a grub screw.

They are also available round or with either one straight side or two straight sides to allow mounting as close as possible to a flat surface or in a corner. Square Brackets are for surface mounting tubes horizontally or vertically and come as split halves.

Adjustable Clip Brackets allow for horizontal mounting and the standoff can be extended using threaded rod. They can be fitted on site, even to Light Bars.

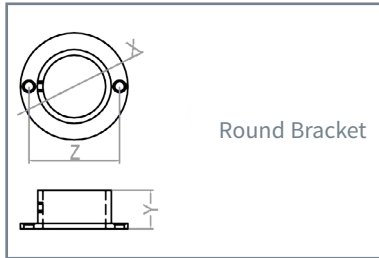

Round Bracket

Dimensions (mm)

Profile	Part No.	X	Y	Z
27mm	ABR27R	50	20	41.5
32mm	ABR32R	55	20	46.5
38mm	ABR38R	62	20	53
44mm	ABR44R	67	20	58.5
44mm	ABR52R	75.5	20	67

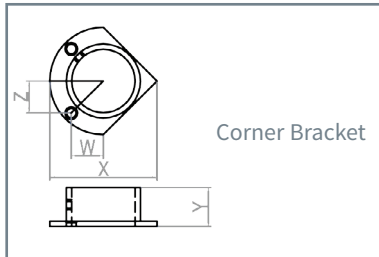

Corner Bracket

Dimensions (mm)

Profile	Part No.	W	X	Y	Z
27mm	ABR27C	10.25	50	20	14.5
32mm	ABR32C	16.5	55	20	16.5
38mm	ABR38C	19.5	62	20	18
44mm	ABR44C	20.5	67	20	20.5
44mm	ABR52C	25.25	84.5	20	25.25

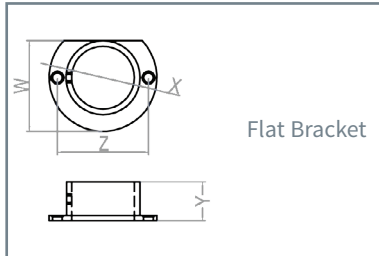
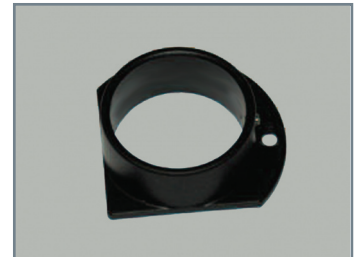

Flat Bracket

Dimensions (mm)

Profile	Part No.	W	X	Y	Z
27mm	ABR27F	41.5	50	20	41.5
32mm	ABR32F	46.5	55	20	46.5
38mm	ABR38F	53	62	20	53
44mm	ABR44F	58.5	67	20	58.5
44mm	ABR52F	67	75.5	20	67

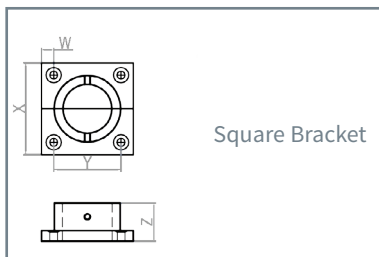
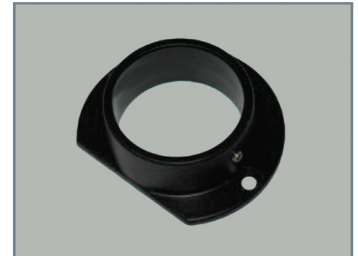

Square Bracket

Dimensions (mm)

Profile	Part No.	W	X	Y	Z
32mm	ABR32S	8	60	44	25
38mm	ABR38S	8	66	50	25

Note: only available for 32mm and 38mm profiles.

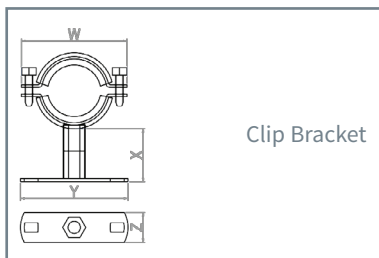
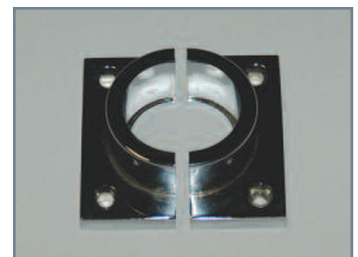

Clip Bracket

Dimensions (mm)

Profile	Part No.	W	X	Y	Z
27/32mm	ABR32N	81.5	34	70	19.5
38/44mm	ABR40N	92	34	70	19.5
52mm	ABR48N	100	34	70	19.5

Note: has a black neoprene lining to help prevent scratching

